

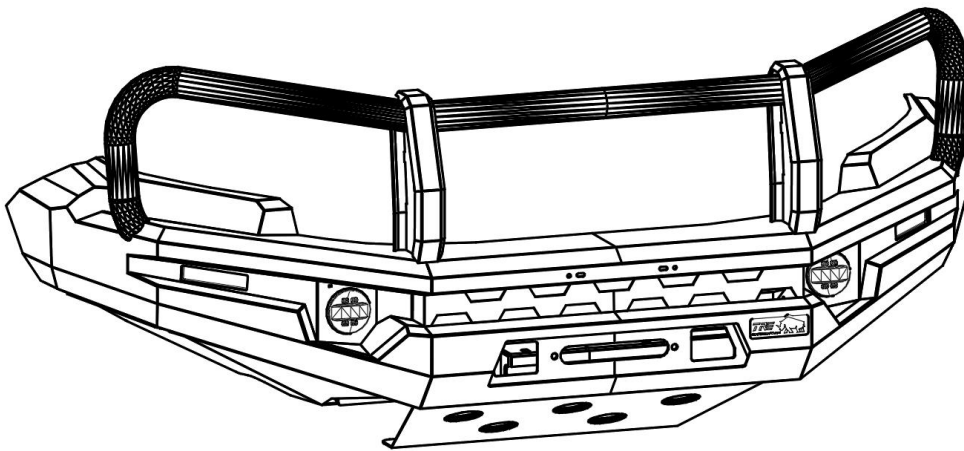

# 2024 TOYOTA HILUX GR

## FRONT BUMPER



**Read the installation instructions carefully to avoid damaging the vehicle or the TRE4x4 bumper !!!**

# PRODUCT OVERVIEW

Let me begin by thanking you for purchasing one of our products. We strive for top quality components and excellent customer service. If you have any issues during installation, don't hesitate to contact us via email at [tech@tre4x4.com](mailto:tech@tre4x4.com) and we will do everything we can to make sure any issues with our product are resolved!

# SAFETY INSTRUCTIONS

For vehicles equipped with airbags;

When installed in accordance with these instructions, the front impact bar will not affect the operation of the SRS airbags.

Please also note the following:

This product must be installed in exact accordance with these instructions using only the hardware provided.

If any impact bar component is damaged, contact your nearest authorized TRE shop.

Do not attempt to repair or modify the impact absorbing system.

Do not use this product on any vehicle make or model other than that specified by TRE.

Do not remove the label from this impact bar.

This product or its mountings must not be modified in any way.

Installation of this product may require the use of specialized tools and/or techniques

It is recommended that this product be installed by trained personnel only

These instructions are correct as of the date of publication.

Responsible for the effects of any subsequent changes made by the vehicle manufacturer

During installation, it is the installer's responsibility to check all components for proper operation/clearance

Always work safely and tighten fasteners to the specified torque unless otherwise instructed

PRODUCER: Made in china

(Please check that the accessories are complete)

TRE4x4 bumpers and accessories

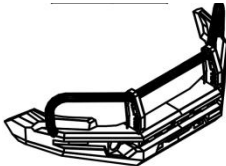

**1X** TRE4x4 bumper

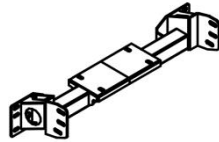

**1X** winch bracket

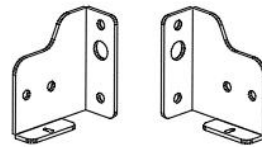

**2X** bracket A

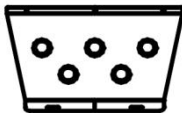

**1X** lower guard

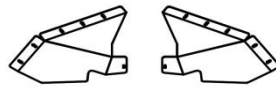

**2X** biplane guard

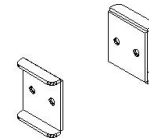

**2X** bracket B

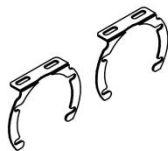

**2X** Light stand A

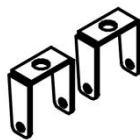

**2X** Light stand B

lights and other accessories



**2X** headlights



**2X** Turn signal

